



Precision Monolithics Inc

OP-420

QUAD MICROPOWER
OPERATIONAL AMPLIFIER

FEATURES

- Low Supply Current 200 μ A Max @ $V_S = +5V$
- Single-Supply Operation +5V to +30V
- Dual-Supply Operation $\pm 2.5V$ to $\pm 15V$
- Low Input Offset Voltage 500 μ V Typ
- Low Input Offset Voltage Drift 5 μ V/ $^{\circ}$ C Typ
- High Common-Mode Input Range ... V- to (V+ - 1.5V)
- High CMRR 100dB Typ
- High Open-Loop Gain 1100V/mV Typ
- LM 148 Pinout
- Available in Die Form

ORDERING INFORMATION †

$T_a = +25^{\circ}C$ $V_{OS} MAX$ (mV)	PACKAGE			OPERATING TEMPERATURE RANGE
	CERDIP 14-PIN	LCC 20-CONTACT	PLASTIC	
2.5	OP420BY	--	--	MIL
2.5	OP420FY	--	--	IND
4.0	OP420CY	OP420CRC/883	--	MIL
4.0	OP420GY	--	OP420GP	XIND
4.0	--	--	OP420GS	XIND
6.0	OP420HY	--	OP420HP	XIND
6.0	--	--	OP420HS	XIND

* For devices processed in total compliance to MIL-STD-883, add /883 after part number. Consult factory for 883 data sheet.

† Burn-in is available on commercial and industrial temperature range parts in CerDIP, plastic DIP, and TO-can packages. For ordering information, see PMI's Data Book, Section 2.

GENERAL DESCRIPTION

The OP-420 quad micropower operational amplifier is a single-chip quad patterned after the OP-20 precision micropower single operational amplifier. A Darlington PNP input stage allows the input common-mode voltage to include V-. The wide input range combined with low power-supply drain

($\sim 40\mu A$ /section at 5V), provides a unique solution for designs requiring high functional density and portable operation. Applications include two-wire transmitters for process control loops, battery-operated remote-line filters, signal preconditioning amplifiers, and a variety of multiple-gain block arrays.

For micropower applications requiring offset nulling, see the OP-20, OP-21 and OP-22 data sheets.

PIN CONNECTIONS

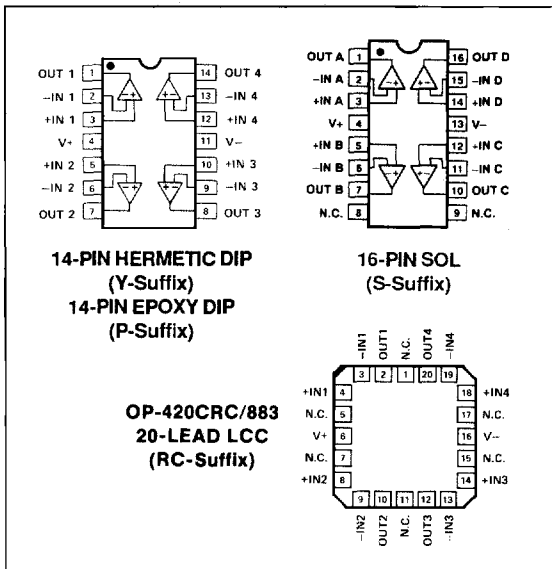

OPERATIONAL AMPLIFIERS/BUFFERS

SIMPLIFIED SCHEMATIC (1/4 Shown)

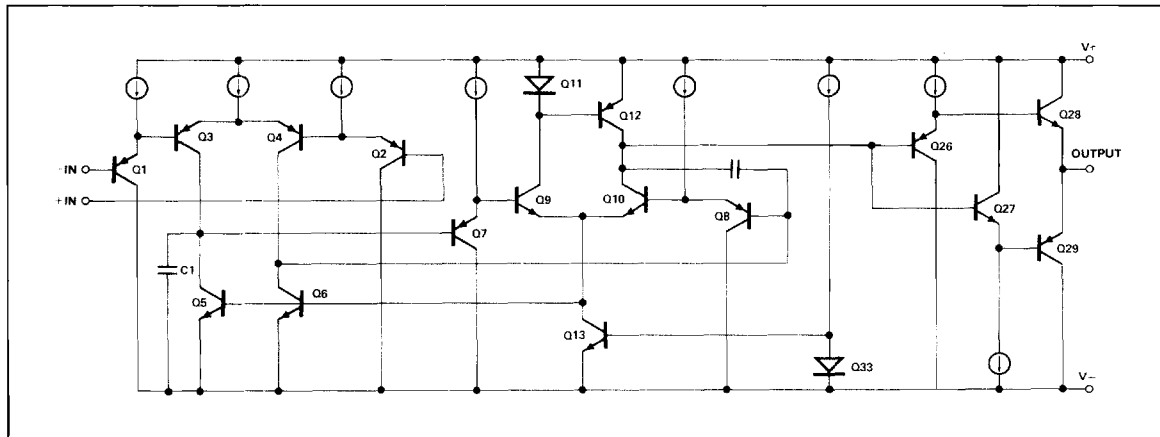

**ABSOLUTE MAXIMUM RATINGS** (Note 1)

Supply Voltage	±18V
Differential Input Voltage	±30V
Input Voltage	Supply Voltage
Output Short-Circuit Duration	Continuous
(One Amplifier Only)	
Storage Temperature Range	-65°C to +150°C
Lead Temperature Range (Soldering, 60 sec)	300°C
Operating Temperature Range	
OP-420BY, OP-420CY, OP-420CRC	-55°C to +125°C
OP-420FY	-25°C to +85°C
OP-420G, OP-420H	-40°C to +85°C
Junction Temperature (T _J)	-65°C to +150°C

PACKAGE TYPE	θ_{JA} (Note 2)	θ_{JC}	UNITS
14-Pin Hermetic DIP (Y)	99	12	°C/W
14-Pin Plastic DIP (P)	76	33	°C/W
16-Pin SOL (S)	92	27	°C/W

NOTES:

1. Absolute maximum ratings apply to both DICE and packaged parts, unless otherwise noted.
2. θ_{JA} is specified for worst case mounting conditions, i.e., θ_{JA} is specified for device in socket for CerDIP and P-DIP packages; θ_{JA} is specified for device soldered to printed circuit board for SOL package.

ELECTRICAL CHARACTERISTICS at $V_S = \pm 15V$, $T_A = +25^\circ C$, unless otherwise noted.

PARAMETER	SYMBOL	CONDITIONS	OP-420B OP-420F			OP-420C OP-420G			OP-420H			UNITS
			MIN	TYP	MAX	MIN	TYP	MAX	MIN	TYP	MAX	
Input Offset Voltage	V_{OS}	$V_S = \pm 2.5V$ to $\pm 15V$	—	0.5	2.5	—	1	4	—	2	6	mV
Input Offset Current (Note 1)	I_{OS}	$V_S = \pm 2.5V$ to $\pm 15V$	—	0.5	1.5	—	0.8	2.5	—	1.2	6	nA
Input Bias Current (Note 1)	I_B	$V_S = \pm 2.5V$ to $\pm 15V$	—	9	20	—	12	30	—	18	40	nA
Input Noise Voltage Density	e_n	$f_O = 10Hz$ $f_O = 100Hz$	—	50	—	—	50	—	—	50	—	nV/ \sqrt{Hz}
Input Noise Current Density	i_n	$f_O = 10Hz$ $f_O = 100Hz$	—	0.12	—	—	0.12	—	—	0.12	—	pA/ \sqrt{Hz}
Input Voltage Range	IVR	$V_+ = +5V, V_- = 0V$ $V_S = \pm 15V$	0/3.5 -15/13.5	—	—	0/3.5 -15/13.5	—	—	0/3.5 -15/13.5	—	—	V
Common-Mode Rejection Ratio	CMRR	$V_+ = +5V, V_- = 0V$ $0V \leq V_{CM} \leq 3.5V$ $V_S = \pm 15V$	83	100	—	80	96	—	76	90	—	dB
		$-15V \leq V_{CM} \leq 13.5V$	83	100	—	80	96	—	76	90	—	
Power Supply Rejection Ratio	PSRR	$V_S = \pm 2.5V$ to $\pm 15V$; & $V_- = 0V, V_+ = 5V$ to $30V$	—	10	30	—	20	50	—	30	80	$\mu V/V$
Large-Signal Voltage Gain	A_{VO}	$R_L = 25k\Omega$, $V_O = \pm 10V$	600	1100	—	400	900	—	200	800	—	V/mV
Slew Rate	SR		—	0.05	—	—	0.05	—	—	0.05	—	V/ μs
Closed-Loop Bandwidth	BW	$A_{VCL} = +1.0$ $R_L = 10k\Omega$	—	150	—	—	150	—	—	150	—	kHz
Output Voltage Swing	V_O	$V_+ = 5V, V_- = 0V$, $R_L = 10k\Omega$ $V_S = \pm 15V$, $R_L = 25k\Omega$	0.7/4.1	—	—	0.8/4.0	—	—	0.9/3.8	—	—	V
			±14.0	—	—	±14.0	—	—	±13.8	—	—	
Supply Current (Four Amplifiers)	I_{SY}	$V_S = \pm 2.5V$, No Load	—	140	200	—	170	300	—	200	400	μA
		$V_S = \pm 15V$, No Load	—	330	360	—	360	460	—	390	600	

NOTE:

1. I_B and I_{OS} are measured at $V_{CM} = 0$.



ELECTRICAL CHARACTERISTICS at $V_S = \pm 15V$, $-55^\circ C \leq +125^\circ C$ for OP-420B and OP-420C, $-25^\circ C \leq T_A \leq +85^\circ C$ for OP-420F, $-40^\circ C \leq T_A \leq +85^\circ C$ for OP-420G and OP-420H, unless otherwise noted.

PARAMETER	SYMBOL	CONDITIONS	OP-420B OP-420F			OP-420C OP-420G			OP-420H			UNITS
			MIN	TYP	MAX	MIN	TYP	MAX	MIN	TYP	MAX	
Average Input Offset Voltage Drift (Note 1)	TCV_{OS}	Unnulled	—	5	10	—	8	15	—	15	25	$\mu V/^\circ C$
Input Offset Voltage	V_{OS}	$V_S = \pm 2.5V$ to $\pm 15V$	—	—	3.5	—	—	5.5	—	—	7.5	mV
Input Offset Current (Note 2)	I_{OS}	$V_S = \pm 2.5V$ to $\pm 15V$	—	—	3	—	—	4	—	—	8	nA
Input Bias Current (Note 2)	I_B	$V_S = \pm 2.5V$ to $\pm 15V$	—	—	30	—	—	40	—	—	60	nA
Input Voltage Range	IVR	$V_+ = +5V, V_- = 0V$ $V_S = \pm 15V$	0/3.2 -15/13.2	—	—	0/3.2 -15/13.2	—	—	0/3.2 -15/13.2	—	—	V
Common-Mode Rejection Ratio	CMRR	$V_+ = +5V, V_- = 0V,$ $0V \leq V_{CM} \leq 3.2V$	76	96	—	73	92	—	73	86	—	dB
		$V_S = \pm 15V,$ $-15V \leq V_{CM} \leq 13.2V$	76	96	—	73	92	—	73	86	—	
Power Supply Rejection Ratio	PSRR	$V_S = \pm 2.5V$ to $\pm 15V$ and $V_- = 0V, V_+ = 5V$ to 30V	—	15	50	—	25	80	—	40	100	$\mu V/V$
Large-Signal Voltage Gain	A_{VO}	$V_S = \pm 15V, R_L = 50k\Omega,$ $V_O = \pm 10V$	300	800	—	200	650	—	100	400	—	V/mV
Output Voltage Swing	V_O	$V_+ = 5V, V_- = 0V,$ $R_L = 20k\Omega$ $V_S = \pm 15V,$ $R_L = 50k\Omega$	0.9/3.9 ± 13.8	—	—	1.0/3.8 ± 13.8	—	—	1.1/3.6 ± 13.6	—	—	V
Supply Current (Four Amplifiers)	I_{SY}	$V_S = \pm 2.5V, \text{ No Load}$	—	170	300	—	210	400	—	250	600	μA
		$V_S = \pm 15V, \text{ No Load}$	—	390	500	—	420	640	—	500	800	

NOTES:

1. Sample tested.
2. I_B and I_{OS} are measured at $V_{CM} = 0$.

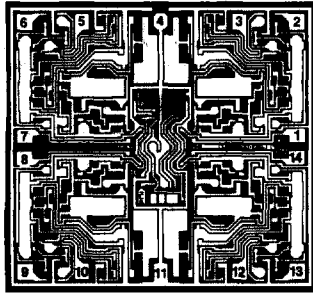
DICE CHARACTERISTICS

DIE SIZE 0.093 × 0.087 inch, 8091 sq. mils
(2.36 × 2.21 mm, 5.22 sq. mm)

1. OUTPUT 1
2. INVERTING INPUT 1
3. NONINVERTING INPUT 1
4. V⁺
5. NONINVERTING INPUT 2
6. INVERTING INPUT 2
7. OUTPUT 2
8. OUTPUT 3
9. INVERTING INPUT 3
10. NONINVERTING INPUT 3
11. V⁻
12. NONINVERTING INPUT 4
13. INVERTING INPUT 4
14. OUTPUT 4

For additional DICE ordering information,
refer to PMI's Data Book, Section 2.

WAFER TEST LIMITS at $V_S = \pm 15V$, $T_A = 25^\circ C$, unless otherwise noted.

PARAMETER	SYMBOL	CONDITIONS	OP-420N LIMIT	OP-420G LIMIT	OP-420GR LIMIT	UNITS
Input Offset Voltage	V_{OS}	$V_S = \pm 2.5V$ to $\pm 15V$	2.5	4	6	mV MAX
Input Offset Current	I_{OS}	$V_S = \pm 2.5V$ to $\pm 15V$, (Note 1)	1.5	2.5	6	nA MAX
Input Bias Current	I_B	$V_S = \pm 2.5V$ to $\pm 15V$, (Note 1)	20	30	40	nA MAX
Input Voltage Range	IVR		-15/13.5	-15/13.5	-15/13.5	V MIN
Common-Mode Rejection Ratio	CMRR	$V^+ = +5V, V^- = 0V$	83	80	76	dB MIN
		$0V \leq V_{CM} \leq 3.5V$ $V_S = \pm 15V, -15V \leq V_{CM} \leq 13.5V$	83	80	76	
Power Supply Rejection Ratio	PSRR	$V_S = \pm 2.5V$ to $\pm 15V$ $V^- = 0V, V^+ = +5V$ to $+30V$	30	50	80	$\mu V/V$ MAX
Large-Signal Voltage Gain	A_{VO}	$R_L = 25k\Omega, V_O = \pm 10V$	600	400	200	V/mV MIN
Output Voltage Swing	V_O	$V^+ = +5V, V^- = 0V$ $R_L = 10k\Omega$	0.7/4.1	0.8/4.0	0.9/3.8	V MAX
		$V_S = \pm 15V$ $R_L = 25k\Omega$	± 14.0	± 14.0	± 13.8	V MIN
Supply Current	I_{SY}	No Load, (Four Amplifiers)	360	460	600	μA MAX

NOTES:

1. I_B and I_{OS} are measured at $V_{CM} = 0$.

Electrical tests are performed at wafer probe to the limits shown. Due to variations in assembly methods and normal yield loss, yield after packaging is not guaranteed for standard product dice. Consult factory to negotiate specifications based on dice lot qualification through sample lot assembly and testing.

TYPICAL PERFORMANCE CHARACTERISTICS

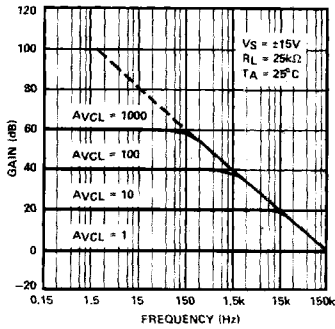
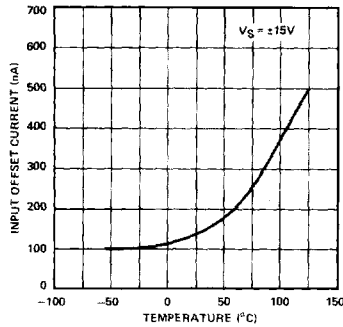
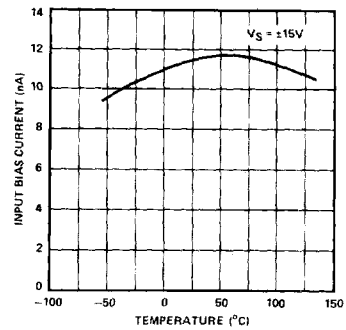
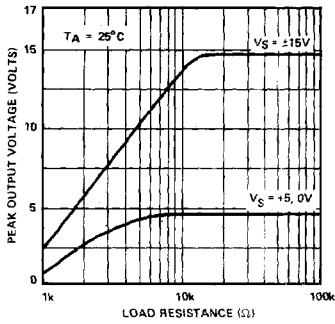
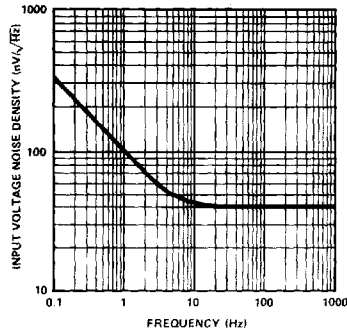
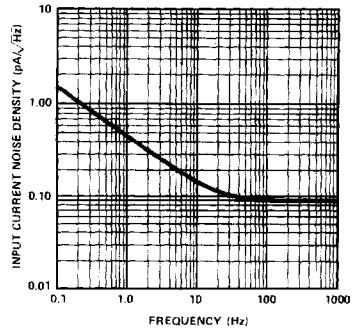
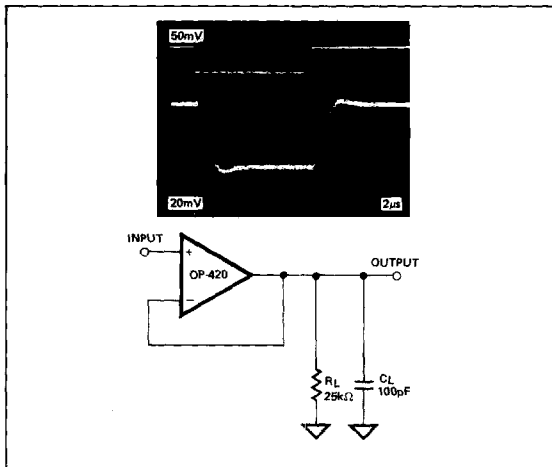
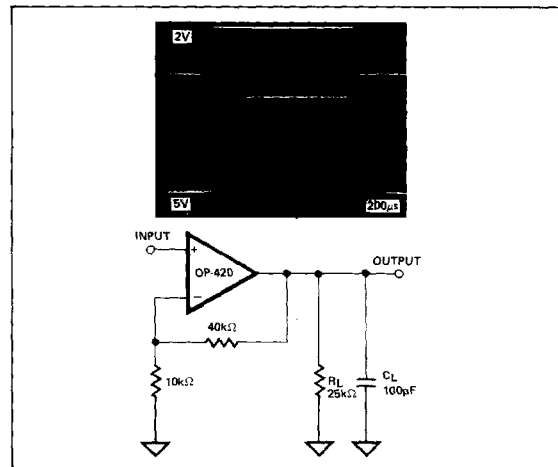
CLOSED-LOOP GAIN vs FREQUENCY

INPUT OFFSET CURRENT vs TEMPERATURE

INPUT BIAS CURRENT vs TEMPERATURE

MAXIMUM OUTPUT VOLTAGE vs LOAD RESISTANCE

INPUT VOLTAGE NOISE DENSITY (e_n) vs FREQUENCY

INPUT CURRENT NOISE DENSITY (i_n) vs FREQUENCY

SMALL-SIGNAL TRANSIENT RESPONSE

LARGE-SIGNAL TRANSIENT RESPONSE

OPERATIONAL AMPLIFIERS/BUFFERS